

Memorex®

MT1091 9" Color Television Owner's Manual

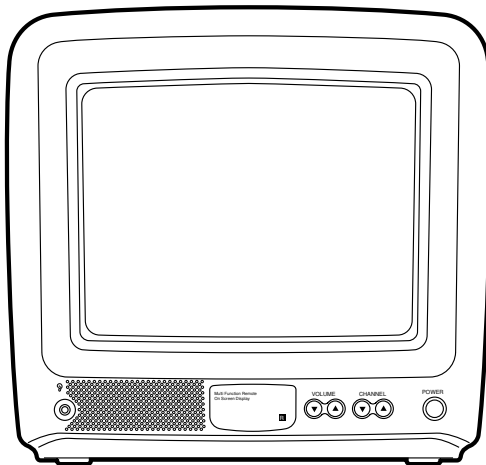

As an ENERGY STAR® Partner, MEMCORP has determined that this product meets the ENERGY STAR® guidelines for energy efficiency.

BEFORE YOU OPERATE YOUR NEW TELEVISION

To get the most from your new color television, read and follow this Owner's Manual carefully.

INSTALLATION GUIDELINES

- Place your TV in a room with adequate ventilation.
- Keep your TV set away from sources of direct heat, such as heat registers or direct sunlight.
- Do not place your TV on soft surfaces, such as rugs or blankets.
- Leave enough room for air to circulate around the bottom, top and back of the set.

ANTENNA CONNECTIONS



- For best picture quality, we recommend that you use an outdoor antenna. Follow instructions on page 6 for proper antenna hookup.

POWER CONNECTION

- Your TV works on normal household current (120 volts, 60 Hz).
For safety purposes, your TV's electrical plug has one blade wider than the other. If you cannot insert the plug fully into the socket, try reversing it.

In the space provided, record the serial and model numbers, located on the rear of the unit.

Serial No. _____ Model No. _____

	CAUTION RISK OF ELECTRIC SHOCK DO NOT OPEN	
CAUTION: TO REDUCE THE RISK OF ELECTRIC SHOCK, DO NOT REMOVE COVER (OR BACK). NO USER SERVICEABLE PARTS INSIDE. REFER SERVICING TO QUALIFIED SERVICE PERSONNEL.		



The lightning flash with the arrowhead symbol within an equilateral triangle, is intended to alert the user to the presence of uninsulated "dangerous voltage" within the product's enclosure that may be of sufficient magnitude to constitute a risk of electric shock to someone.



The exclamation point within an equilateral triangle is intended to alert the user to the presence of important operating and maintenance (servicing) instructions in the literature accompanying the appliance.

WARNING: TO REDUCE THE RISK OF FIRE OR ELECTRIC SHOCK, DO NOT EXPOSE THIS APPLIANCE TO RAIN OR MOISTURE.

FEATURES

- On-screen graphics guide you through setup features and operations
- Automatic programming of channels allows easy selection of stations available in your viewing area
- Sleep timer programs the TV to turn itself off at a preset time
- One day timer programs the TV to come on once at a preset time
- Weekly timer programs the TV to come on at a preset time every day
- 24-button infrared remote control allows remote operation
- VHF/UHF/CATV tuning allows reception of standard broadcasts or cable TV channels

SPECIFICATIONS

Power Input:	AC: 120V, 60Hz DC: 12V
Power Consumption:	AC: 55Watts DC: 36Watts
Chassis Construction:	IC Solid State
Picture Tube:	9" (measured diagonally)
Speaker:	2.8 x 1.6 in. (70 x 40 mm) Oval, 8 ohms
Tuner:	181 Channel, Freq. Synthesized
Remote Control:	Infrared, Direct Access 24 Key, 2 "AA" batteries
Receiving Channels:	
VHF	2-13
UHF	14-69
CATV	
Mid Band	14-22
Super Band	23-36
Hyper Band	37-65
Ultra Band	66-94, 100-125
Sub Mid Band	1, 95-99
Cabinet:	Monitor Style
Antenna Input Impedance:	75 ohm (VHF/UHF) Coaxial Input

CAUTION: TO PREVENT ELECTRIC SHOCK, MATCH WIDE BLADE OF PLUG TO WIDE SLOT AND FULLY INSERT.

LOCATION OF CONTROLS

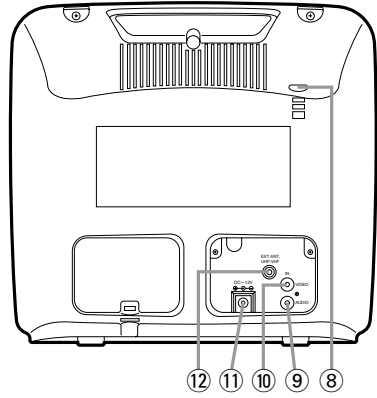
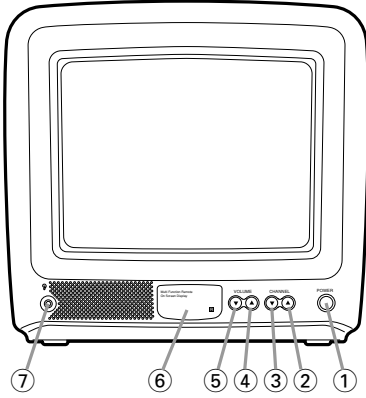

- 1 POWER SWITCH
- 2 CHANNEL ▲ (UP) BUTTON
- 3 CHANNEL ▼ (DOWN) BUTTON
- 4 VOLUME ▲ (UP) BUTTON
- 5 VOLUME ▼ (DOWN) BUTTON
- 6 REMOTE CONTROL SENSOR

- 7 EARPHONE JACK (🎧)
- 8 ANTENNA HOLDER
- 9 AUDIO IN (put) JACK
- 10 VIDEO IN (put) JACK
- 11 DC INPUT JACK
- 12 VHF/UHF EXT. ANT. JACK

REMOTE CONTROL

The REMOTE CONTROL unit requires two 1.5 volt "AA" size batteries. The BATTERY COMPARTMENT is located on the back of the unit. To open, press down of the lid and slide toward the bottom of the unit. Install the batteries exactly as shown by the diagram in the compartment.

NOTE: If one or both of the batteries are reversed, the REMOTE CONTROL will not operate and the unit may be damaged.

This REMOTE CONTROL unit uses an INFRARED WIRELESS CONTROL SYSTEM. This means that the remote commands are sent out as invisible light. For best operation, aim the REMOTE CONTROL unit directly at the REMOTE CONTROL SENSOR window on the lower center front of the TV. Please note that furniture or other solid objects can block the path of the infrared light. Dark walls might absorb the light.

Do not allow strong sunshine to fall on the TV set front panel as this may affect the operation of the remote control. In this case, tune the TV away from the light or darken the room slightly.

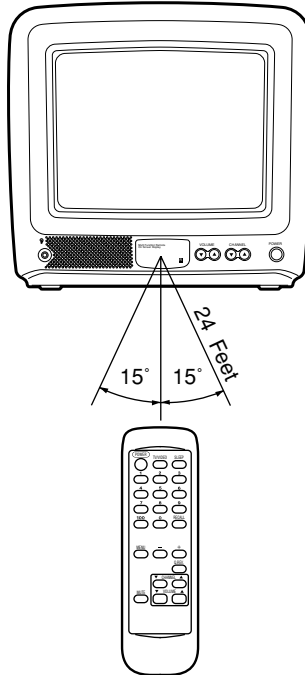

Remote Control

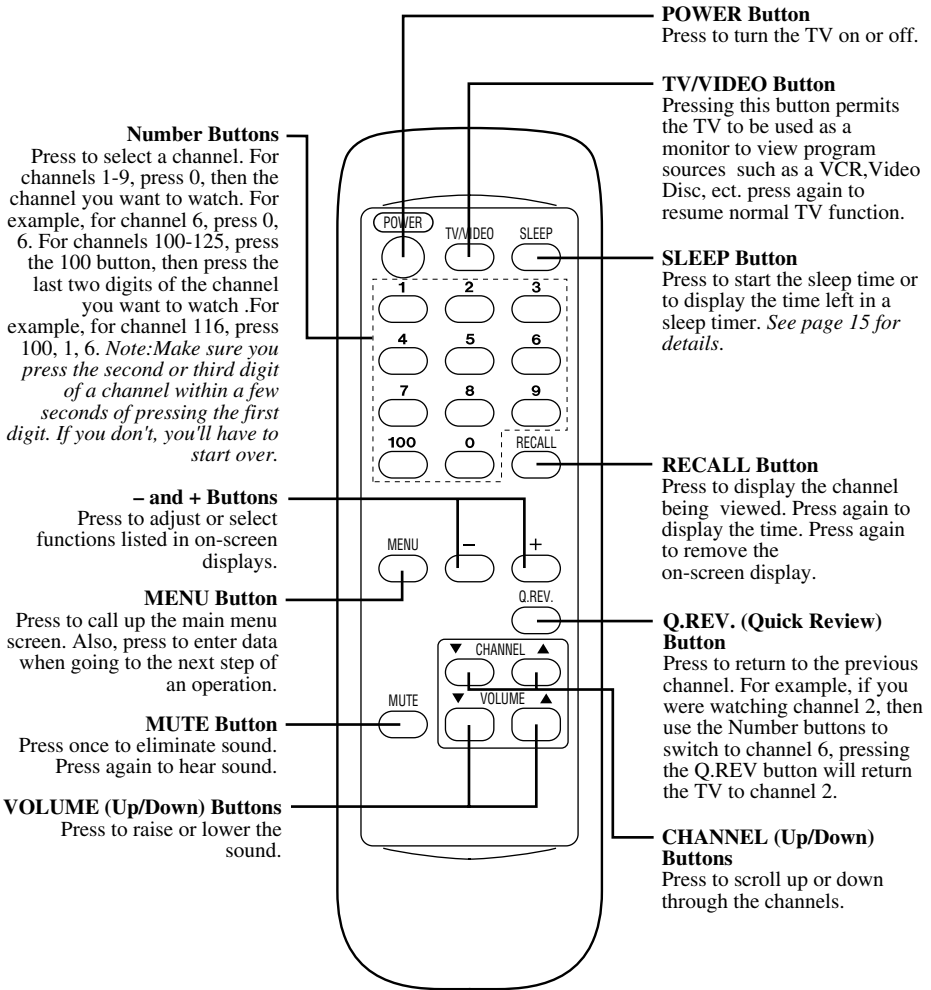

ANTENNA CONNECTIONS

If you are using an indoor antenna (included) or an outdoor antenna (not included) follow the instructions below that correspond to your antenna system. If you are using a cable television service (CATV), refer to CATV connections.

Combination VHF/UHF Antenna (Single 75 ohm cable or 300 ohm twin-lead wire)

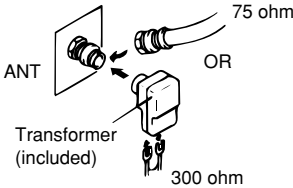

Connect the 75 ohm cable from combination VHF/UHF antenna to the antenna jack.

OR

If your combination antenna has a 300 ohm twin-lead wire, use the 300-75 ohm matching transformer (included)

CATV CONNECTIONS

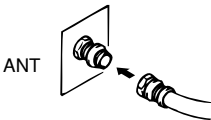

For subscribers to basic cable service. For basic cable service without a converter/descrambler box, connect the CATV 75 ohm coaxial cable directly to the antenna jack on back of the unit.

Connecting an Internal Antenna

Your TV comes with an internal antenna. Use it if you want to place the TV where there is no outdoor connection.

- 1 Place the rod antenna (included) into the antenna holder on the back of the TV cabinet. Push it down until it locks in place.
- 2 Connect the antenna leads (flat prongs) to the two screws on the transformer (included).
- 3 Push the round terminal on the back of the transformer into the EXT. ANT. jack on the back of the TV.
- 4 Extend and adjust the antenna.

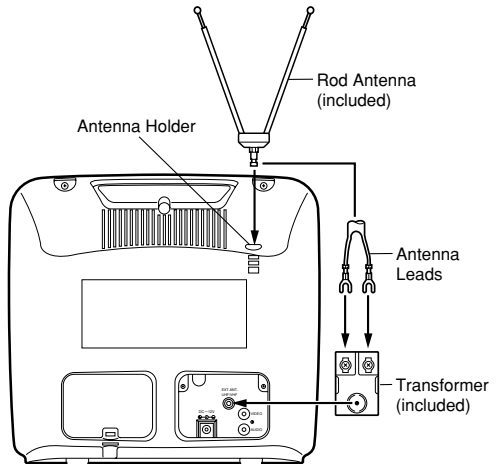

Some cable companies offer “premium pay” channels in which the signal is scrambled. Descrambling these signals for normal viewing requires the use of a descrambler device which is generally provided by the cable company.

The illustrations below show how to connect these types of converter/descrambler devices with the TV’s VHF antenna jack.

You may need a two-set signal splitter (sometime called a “two-set coupler”) and an A/B switch box from the cable installer or an electronic supply store. With the A/B switch in the “B” position, you can then tune directly to any non-scrambled channels using your TV’s tuning system or remote control. In the “A” position, you can tune your TV to the output channel of the decoder (generally Channel 3/4) and use the cable company’s equipment to tune scrambled channels. Since cable systems vary, you may wish to consult your local cable company.

For subscribers to scrambled pay cable service

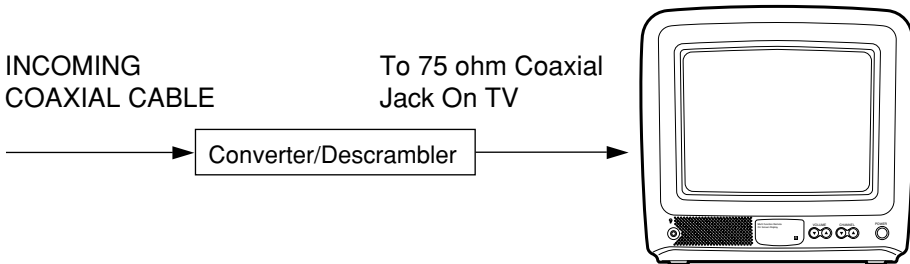

To allow viewing of all channels through converter/descrambler. TV must be set to the output channel of the converter/ descrambler (usually ch 3 or 4).

NOTE: If you subscribe to a cable service which requires you to use a converter/descrambler box, follow the connections shown above.

If your basic cable channels are unscrambled and are using a converter/descrambler for premium channels, follow the connections shown below.

For subscribers of unscrambled basic cable with a converter/descrambler box for viewing premium channels.

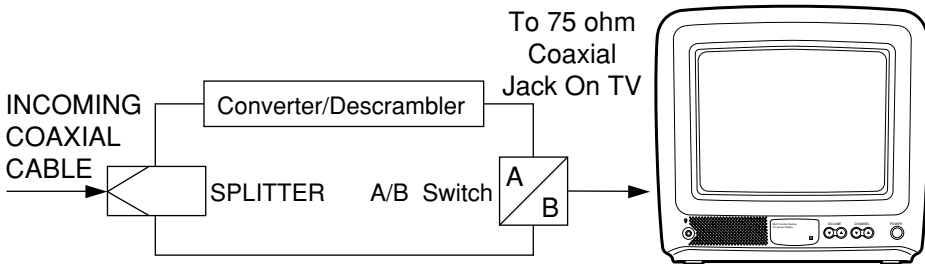

A—Allows viewing of scrambled channels through converter/descrambler box.

B—Allows full use of TV tuner and Remote Control.

NOTE: For other cable connections, consult your cable company.

POWER SOURCE

You can connect the TV to a household outlet or to the cigarette lighter of your car.

AC Power

Connect the polarized AC cord plug to a 120V AC 60Hz household outlet.

NOTES

- 1. NEVER CONNECT THE AC LINE CORD PLUG TO OTHER THAN THE SPECIFIED VOLTAGE.
USE THE ATTACHED POWER CORD ONLY.*
- 2. IF THE POLARIZED AC CORD DOES NOT FIT INTO A NON-POLARIZED AC OUTLET, DO NOT ATTEMPT TO FILE OR CUT THE WIDE BLADE.*

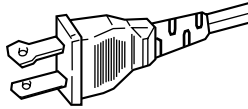

Polarized AC Cord

Cigarette Lighter Power

- 1 Insert one end of the DC car cord (included) into the DC input jack on the back of the TV.
- 2 Insert the other end of the DC car cord into the cigarette lighter in your car.

NOTES

The polarity of the DC Input jack is not like most others. Attaching a DC power cord of reverse polarity will make the four-amp fuse blow. Therefore, use only the DC car cord included with your TV for connection to the cigarette lighter of your car.

When using an external power source:

- *It may be difficult to obtain good reception while the car is moving.*
- *It is recommended that you operate the TV with your car engine idling when very low outside temperatures cause difficulty in starting the engine.*
- *Do not operate the TV when starting your car engine. Doing so may overload the engine.*
- *When you are finished watching TV, turn the power off and disconnect the DC car cord from the cigarette lighter. If you don't do this, you may run down your car's battery.*
- *Do not operate your TV with a dirty cigarette lighter. Cigarette ash may cause the DC car cord plug to become overheated.*

QUICK USE GUIDE

If you're already familiar with TV hookup and operation, just follow the quick steps below to make some basic connections and adjustments before using your new TV.

- 1 Place batteries in the remote control. (See page 4).
- 2 Connect the TV to an antenna or cable. (See page 6).
- 3 Connect a power supply.
- 4 Press the POWER button to turn the TV on.
- 5 Press the MENU button to bring up the main menu screen. Press the + or – button to highlight LANGUAGE, then press the MENU button until the on-screen menu is in the language you want it to be in. (See page 9).
- 6 Use the + or – button to highlight CH PROGRAM, then press the MENU button to select it. Press the + or – button to highlight AIR/CABLE, then press the MENU button until the input you have connected to your TV (AIR for antenna or CABLE for cable) appears to the right of AIR/CABLE. Then use the + or – button to highlight EXIT, and press the MENU button to exit. (See page 11 for details).
- 7 Go to page 11 and program channels.
- 8 Use the CHANNEL (Up/Down) or Number buttons to select a channel for viewing. Use the VOLUME (Up/Down) buttons to adjust the sound level.

SELECTING A LANGUAGE

The menu screen that appears when you press the MENU button can be programmed to appear in English, French, or Spanish. Follow the directions below to program the menu screen to appear in a language other than the one that is now on-screen when you press the MENU button.

- 1 Press the MENU button to bring up the menu-screen.
- 3 Press the MENU button until the menu screen is in the language you want to select.
- 4 Use the + or – button to highlight EXIT.

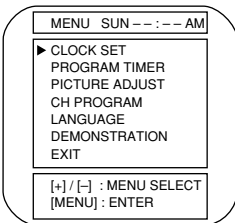

- 2 Use the + or – button to highlight LANGUAGE.

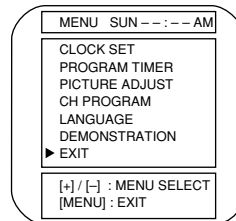
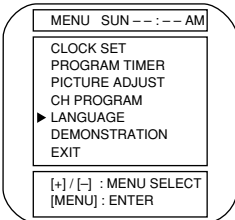

- 5 Press the MENU button to exit.

SETTING THE CLOCK

- 1 Press the MENU button twice to bring up the menu screen and select CLOCK SET.

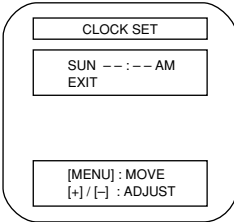

- 2 Use the + or – button to select the correct day of the week.

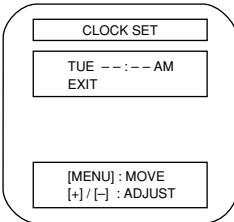

- 3 Press the MENU button to go to the next step.

- 4 Use the + or – button to select the correct hour(s).

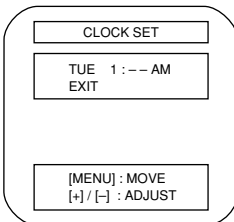

- 5 Press the MENU button to go to the next step.

- 6 Use the + or – button to select the correct minute(s).

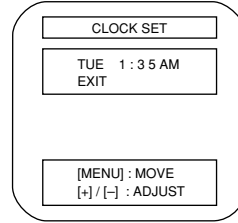

- 7 Press the MENU button to go to the next step.

- 8 Use the + or – button to select AM or PM.

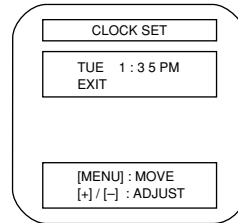

- 9 Press the MENU button. EXIT will flash.

- 10 Press the + or – button to exit.

NOTES

- To display the day and time at any time. Press the **RECALL** button twice. To remove the display, press the **RECALL** button again.
- To correct the day or time, follow step 1 to bring up the clock set menu. Then press the **MENU** button until the section of the display you want to correct is flashing. Use the + or – button to correct the day or time. Finally, press the **MENU** button until **EXIT** is flashing, then press the + or – button to exit.
- You may have to reset the clock if there is a power outage or if you unplug the TV.

PROGRAMMING CHANNELS

With automatic programming, the TV automatically places every channel you receive in its memory, allowing you to scan through those channels when you press the CHANNEL (Up/Down) buttons. With manual programming, you tell the TV what channels you want to scan through when you press the CHANNEL (Up/Down) buttons.

Automatic Programming

- 1 Press the MENU button to bring up the menu screen.
- 4 Use the + or – button to highlight AUTO SEARCH.

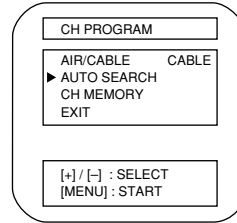
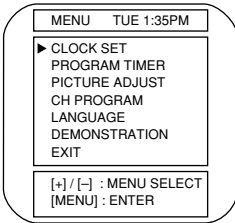

- 2 Use the + or – button to highlight CH PROGRAM, then press the MENU button to select it.

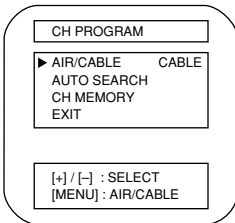

- 5 Press the MENU button to select AUTO SEARCH. The TV will flip through all of its 125 channels, placing the ones you receive in its memory. When it is finished, the channel program screen will appear on-screen again.

- 6 Use the + or – button to highlight EXIT.

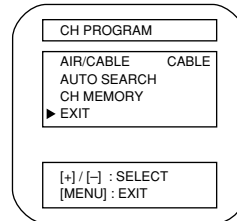

- 3 If you have a cable connected to the TV, press the MENU button until CABLE appears to the right of AIR/CABLE. If you have an antenna connected to the TV, press the MENU button until AIR appears to the right of AIR/CABLE.

- 7 Press the MENU button to exit.

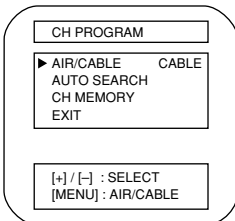

NOTES

To stop automatic programming while it is in progress, press the MENU button.

ADDING/DELETING CHANNELS

Manual Programming

- 1 Press the MENU button to bring up the menu screen.

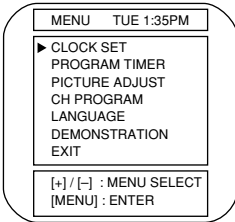

- 2 Use the + or – button to highlight CH PROGRAM, then press the MENU button to select it.

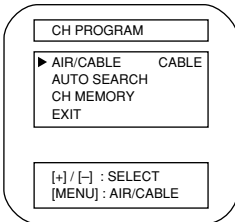

- 3 Use the + or – button to highlight CH MEMORY.

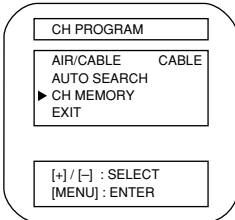

- 4 Press the MENU button to select CH MEMORY.

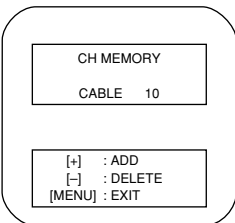

- 5 Press the CHANNEL (Up or Down) button or Number buttons to select the channel you want to add to or delete from the TV's memory.

- 6 Press the + button to add the channel (it will turn white). Or, press the – button to delete the channel (it will turn red).

- 7 Follow steps 5 and 6 to add or delete other channels.

- 8 Press the MENU button to return to the channel program screen.

- 9 Press the MENU button to exit while EXIT is highlighted.

NOTES

- If you don't program channels, you will still receive channels when you press the CHANNEL (Up) and (Down) buttons or Number buttons. But you will also have to scan through channel that have no reception or very poor reception when you press the CHANNEL (Up) and (Down) buttons.
- You may have to reprogram channels if there is a power outage or if the TV is unplugged.

SETTING THE TIMERS

You can program your TV to turn on a specific channel at a preset time once (one day timer) or at the same time every day or every week (weekly timer). You also can program your TV to turn itself off after a specified amount of time (sleep timer).

One Day Timer

- 1 Press the MENU button to bring up the menu screen.

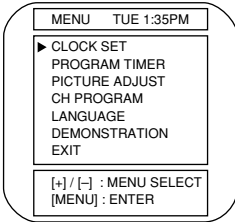

- 2 Use the + or – button to highlight PROGRAM TIMER, then press the MENU button.

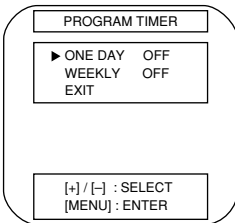

- 3 While ONE DAY is highlighted, press the MENU button. The OFF (or ON) to the right of ONE DAY will flash.

- 4 Press the + or – button until ON appears beside ONE DAY.

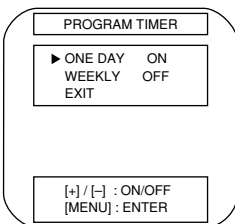

- 5 Press the MENU button to bring up the one day timer screen.

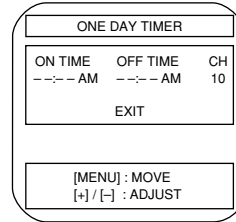

- 6 Use the + or – button to select the hour you want the timer to come on, then press the MENU button. Use the + or – button to select the minute(s) you want the timer to come on, then press the MENU button. Use the + or – button to select AM or PM, then press the MENU button. The OFF TIME changes to exactly three hours after the ON TIME. To change the OFF TIME follow the same steps you did to set the ON TIME.

- 7 Use the CHANNEL (Up or Down) buttons, + or – buttons, or Number buttons to select the channel you want the TV to come on, then press the MENU button.

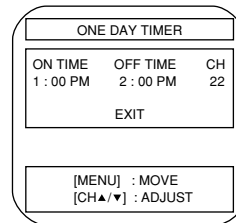

- 8 While EXIT is blinking, press the + or – button to exit.

NOTES

- To cancel a timer, follow steps 1 through 3. At step 4, use the + or – button to turn the ON to OFF.
- The one day timer has priority when the same time value is set for the ON TIME field of both the one day timer and the weekly timer.

Weekly Timer

- 1 Press the MENU button to bring up the menu screen.

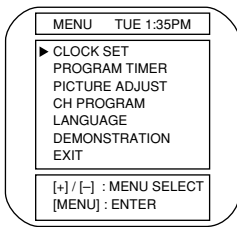

- 2 Use the + or – button to highlight PROGRAM TIMER, then press the MENU button.

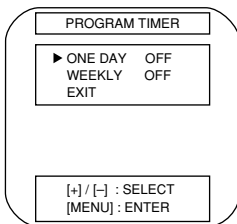

- 3 Press the + or – button to select WEEKLY, then press the MENU button. The word OFF (or ON) to the right of WEEKLY will flash.

- 4 Press the + or – button until ON appears beside WEEKLY.

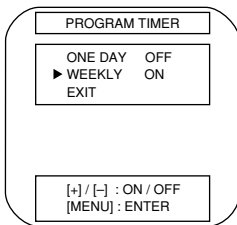

- 5 Press the MENU button to bring up the weekly timer screen.

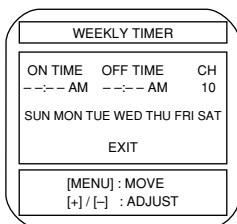

- 6 Use the + or – button to select the hour you want the timer to come on, then press the MENU button. Use the + or – button to select the minute(s) you want the timer to come on, then press the MENU button. Use the + or – button to select AM or PM, then press the MENU button. Follow the same steps to set the time off.

- 7 Use the CHANNEL (Up or Down) buttons, + or – buttons, or Number buttons to select the channel you want the TV to come on, then press the MENU button.

- 8 Press the MENU button to select the day(s) of the week you do not want the TV to come on. Once that day is flashing, use the + or – button to unselect that day of the week (the TV will not come on) signified in red or reselect that day of the week (the TV will come on) signified in white.

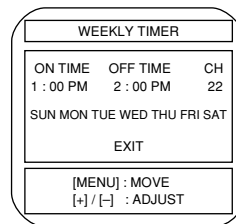

- 9 While EXIT is blinking, press the + or – button to exit.

NOTES

- To cancel a timer, follow steps 1 through 3. Then use the + or – button to turn the ON to OFF.
- The timer will come on only on the days that appear in white on the weekly timer screen.

Sleep Timer

- 1 Press the SLEEP button to bring up the sleep timer screen.
- 2 Press the SLEEP button until the desired sleep time (10, 20, 30, 40, 50, 60, 70, 80 or 90 minutes) appears on-screen. The timer will begin counting down to zero, and the on-screen display will disappear. When the timer reaches zero, the TV will turn itself off.

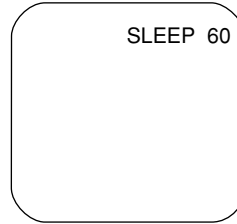
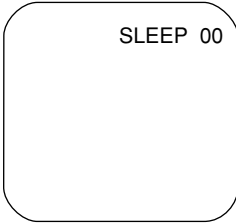

NOTES

- To check the time remaining for a sleep timer, press the SLEEP button. The time remaining will appear on-screen.
- To cancel a sleep timer, follow step 1 to bring up the sleep timer screen. Then press the SLEEP button until 00 appears on-screen.
- You must select a sleep time within three seconds of bringing up the sleep timer screen. Otherwise, the screen will disappear and you will have to start over.

ADJUSTING THE PICTURE

- 1** Press the MENU button to bring up the menu screen.

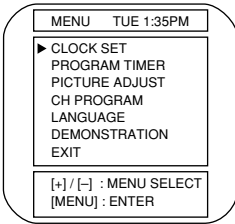

- 2** Use the + or – button to highlight PICTURE ADJUST, then press the MENU button.

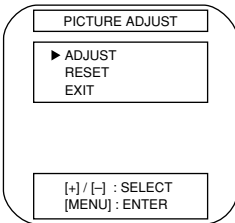

- 3** Press the MENU button while ADJUST is highlighted.

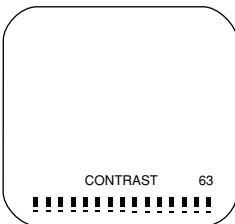

- 4** Press the MENU button until the adjustment you want to make (CONTRAST, BRIGHTNESS, COLOR, TINT or SHARPNESS –see chart at right for details) appears at the bottom of the screen.

- 5** Use the + or – button to adjust the picture. The bar scale at the bottom of the screen shows the level of adjustment.

- 6** Press the MENU button until the picture adjust screen appears.

- 7** Use the + or – button to highlight EXIT, then press the MENU button to exit.

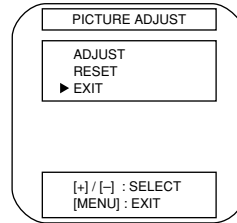

Picture Adjustments

FUNCTION	– Button	+ Button
CONTRAST	Weaker	Stronger
BRIGHT(ness)	Darker	Lighter
COLOR	Paler	Deeper
TINT	Skin tones to purple	Skin tones to green
SHARPNESS	Softer	Sharper

NOTES

To reset the picture adjustments to their original state, follow steps 1 and 2 above. Use the + or – button to highlight RESET, then press the MENU button. To exit, press the MENU button while EXIT is highlighted.

USING THE AUDIO, VIDEO AND EARPHONE JACKS

Audio/Video Input

The AUDIO and VIDEO IN (put) jacks on the back of the TV allow you to receive audio (sound) and video (picture) from external sources, such as VCR, Video Disc, etc. Follow the instructions below to play video from an external source.

- 1 Use audio/video cables (not included) to connect the AUDIO and VIDEO IN (put) jacks on the back of the TV to audio and video output jacks on an external source.
- 2 Press the TV/VIDEO button to select the VIDEO mode and the VIDEO indication will appear on the screen.
- 3 Operate the VCR, Video Disc or etc. as described in its owner's manual. The TV will monitor playback.

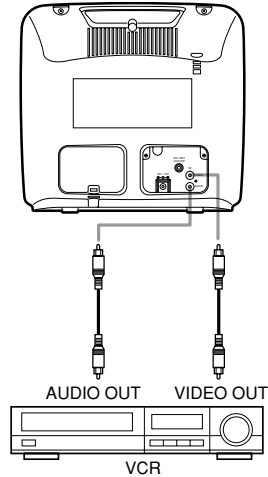

Earphone Jack Operation

Insert an earphone (not included) into the Earphone jack for private listening. When the earphone is in use, the TV's speaker is automatically shut off.

NOTES

- You must return the TV to TV mode for regular TV viewing.
- If the TV does not receive a signal from an external source, the VIDEO display will appear on-screen.

DEMONSTRATION MODE

When placed in demonstration mode, your TV will display some of its features on-screen. Follow the directions below to enter demonstration mode. To exit at any time, simply press the MENU button.

- 1 Press the MENU button to bring up the menu screen.
- 2 Use the + or – button to select DEMONSTRATION, then press the MENU button. A demonstration of the TV's features will begin.

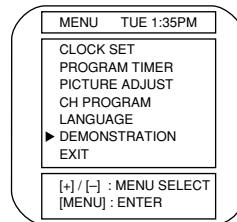
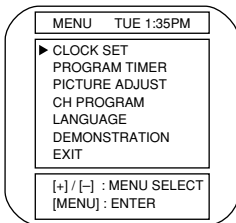

- 3 Press the MENU button to stop.

CABLE TV OPERATION

- 1** Press the MENU button to bring up the main menu screen.
- 2** Use the + or – button to highlight CH PROGRAM, then press the MENU button to select it.
- 3** Press the MENU button until CABLE appears to the right of AIR/CABLE.

On CATV (Cable Television) systems, programs are brought into the home on VHF channels 2–13, mid-band channels A–I, super band channels J–W, hyper band channels AA–CCC, ultra band channels W+30–W+84 and sub midband channels (5A, A5–A1). When CATV is selected, the numbers will change color from yellow to green to indicate the TV is in the cable mode. Channels 2 through 13 are selected directly. Channel A can be tuned in by selecting number 14 on this TV, channel B by selecting number 15, and so on as follows:

Channel number on TV		14	15	16	17	18	19	20	21	22	23																						
Corresponding CATV Channel		A	B	C	D	E	F	G	H	I	J																						
24	25	26	27	28	29	30	31	32	33	34	35	36	37	38	39																		
K	L	M	N	O	P	Q	R	S	T	U	V	W	AA	BB	CC	W+1	W+2	W+3															
40	41	42	43	44	45	46	47	48	49	50	51	52	53	54	55																		
DD	EE	FF	GG	HH	II	JJ	KK	LL	MM	NN	OO	PP	QQ	RR	SS	W+4	W+5	W+6	W+7	W+8	W+9	W+10	W+11	W+12	W+13	W+14	W+15	W+16	W+17	W+18	W+19		
56	57	58	59	60	61	62	63	64	65	66	67	68	69	70	71																		
TT	UU	VV	WW	XX	YY	ZZ	AAA	BBB	CCC	W+20	W+21	W+22	W+23	W+24	W+25	W+26	W+27	W+28	W+29	W+30	W+31	W+32	W+33	W+34	W+35								
72	73	74	75	76	77	78	79	80	81	82	83	84	85	86	87																		
W+36	W+37	W+38	W+39	W+40	W+41	W+42	W+43	W+44	W+45	W+46	W+47	W+48	W+49	W+50	W+51																		
88	89	90	91	92	93	94	95	96	97	98	99	100	101	102	103																		
W+52	W+53	W+54	W+55	W+56	W+57	W+58	A5	A4	A3	A2	A1	W+59	W+60	W+61	W+62																		
104	105	106	107	108	109	110	111	112	113	114	115	116	117	118	119																		
W+63	W+64	W+65	W+66	W+67	W+68	W+69	W+70	W+71	W+72	W+73	W+74	W+75	W+76	W+77	W+78																		
120	121	122	123	124	125	1	5A																										
W+79	W+80	W+81	W+82	W+83	W+84																												

NOTE: The actual number of channels received depends upon channel reception in your area or your cable system.

Most CATV systems use letters to designate channels but others use numbers. To tune in a numbered channel, select the same number on the TV. Consult your local Cable TV company to find out which of these channels are receivable and which type of Cable system is used in your area. (Some cable TV systems use scrambled or encoded signals and require special converters to receive these channels.)

BEFORE REQUESTING SERVICE

Before requesting service, check the following list of problems and solutions. You may be able to solve the problem yourself.

PROBLEM	SOLUTION
No Power	<ul style="list-style-type: none"> • Make sure the unit is plugged in. • Unplug the unit from the electrical outlet for 60 seconds. Then plug it in and turn it on again.
No picture	<ul style="list-style-type: none"> • Make sure the antenna is properly connected at the back of the TV. • Make sure the antenna is not broken. • Adjust the brightness and contrast controls.
No Sound	<ul style="list-style-type: none"> • Use the VOLUME (Up/Down) buttons to turn up the volume. • Make sure the sound is not muted by pressing the MUTE button.
No Color	<ul style="list-style-type: none"> • Make sure the show is being transmitted in color by checking to see if another channel is in color. • Adjust the color control.
Wrong Color	<ul style="list-style-type: none"> • Adjust the color and tint controls.
Picture Too Light/Dark	<ul style="list-style-type: none"> • Adjust the brightness and contrast controls.
Picture Interference	<ul style="list-style-type: none"> • Check the antenna for shorted or broken wires. • Reposition the antenna. • Try another channel to make sure there is not station trouble or local interference (such as electric motors). If possible, minimize by adjusting the antenna.
Remote control Doesn't Work	<ul style="list-style-type: none"> • Make sure batteries are inserted in the remote control. • Make sure the remote control is aimed directly at the remote sensor on the TV.



If you are still in need of assistance,
please call customer service at
1-800-919-3647